

Tubagem e acessórios

Sistemas de Lubrificação

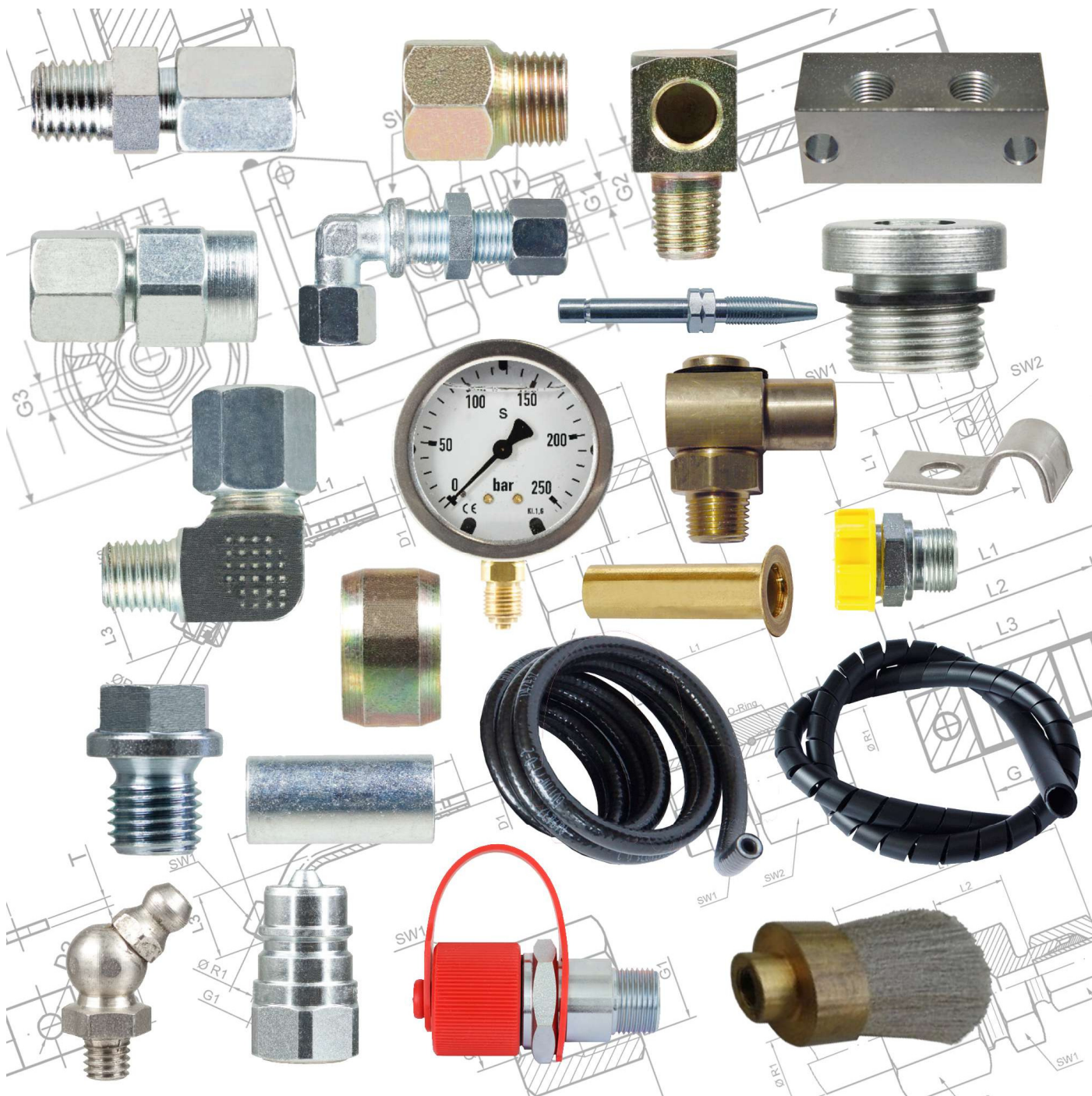

Rua da Charneca de Cima Arm J - Ral - 2710-446 Sintra
Telefone: +351 219672359
Fax: +351 219673040
Email: geral@peixotoecarmo.com
www.peixotoecarmo.com



Acessórios de porca e bicone para sistemas de lubrificação

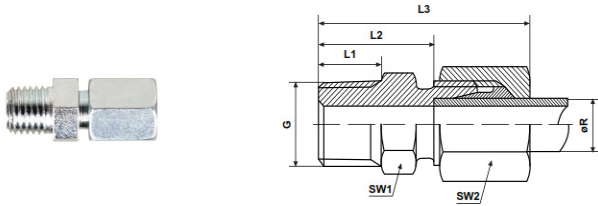

Código	Referencia	G	R	SW1	SW2	L1	L2	L3
Uniões direitas tubo rosca								
VGL1010	406-443	M6x1k	6	11	12	8	14,5	6
VGL1008	406-433	M8x1k	6	11	12	8	14,5	6
VGL1005	406-423	M10x1k	6	11	12	8	14,5	6

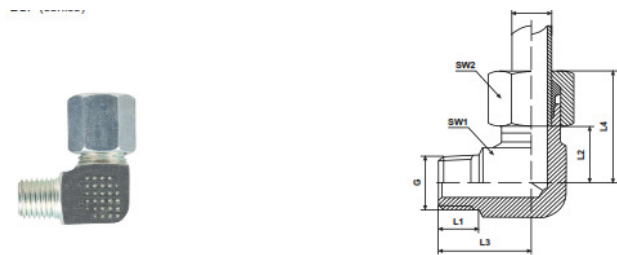

Código	Referencia	G	R	SW1	SW2	L1	L2	L3
Joelhos tubo rosca								
VGL1011	406-445	M6x1k	6	11	12	8	14,5	6
VGL1009	406-435	M8x1k	6	11	12	8	14,5	6
VGL1006	406-425	M10x1k	6	11	12	8	14,5	6

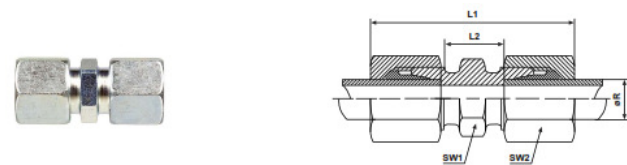

Código	Referencia	R	SW1	SW2	L1	L2
Uniões tubo-tubo						
VGL1007	406-426	6	11	12	32	9



Código	Referencia	G	R	SW	L
Porcas					
VGL1127	406-332	M10x1	6	12	11,5
Bicones					
VGL1126	406-331		6		7

Acessórios rápidos de alta pressão para sistemas de lubrificação

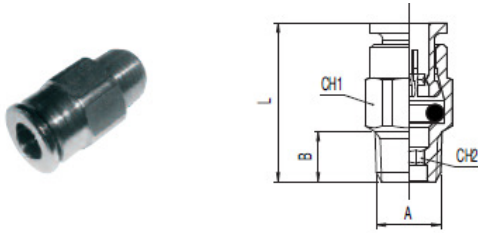

Código	Referencia	A	D	B	CH1	CH2
Uniões direitas rápidas						
VGL1169	406-443-VS	M6x1k	6	6	12	2,5
VGL1170	406-433-VS	M8x1k	6	6	12	3
VGL1147	406-423-VS	M10x1k	6	6,5	12	3

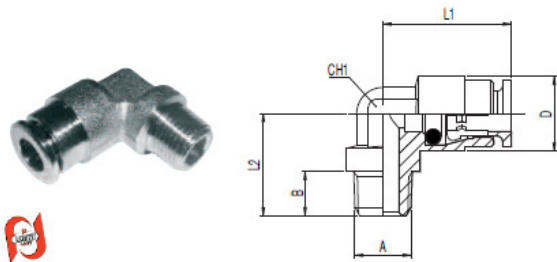

Código	Referencia	A	O	CH1	B	L1	L2	D
Joelhos rápidos								
VGL1172	406-445-VS	M6x1k	6	10	6	21	15	10,5
VGL1173	406-435-VS	M8x1k	6	10	6	21	15	10,5
VGL1148	406-425-VS	M10x1k	6	10	6,5	21	15	10,5

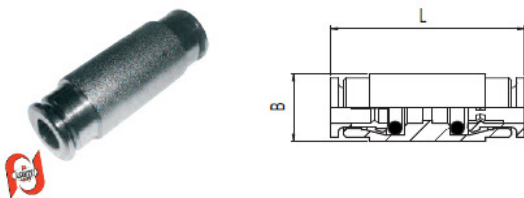

Código	Referencia	O	L
Uniões tubo-tubo			
VGL1171	406-426-VS	6	34,5

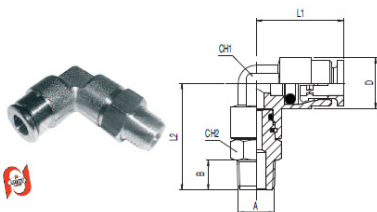

Código	Referencia	A	O	CH1	B	L1	CH2	D
Joelhos rotativos								
VGL1174	406-445R-VS	M6x1k	6	10	6	21	11	13
VGL1175	406-435R-VS	M8x1k	6	10	6	21	11	13
VGL1176	406-425R-VS	M10x1k	6	10	6,5	21	11	13

Adaptadores para sistemas de lubrificação

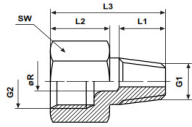

Código	Referencia	G1	G2	R	SW	L1	L2	L3
Adaptadores Macho Fêmea								
VGL1078	404-663k	M6x1k	M8x1	4	11	6,5	10	18
VGL1077	404-003k	M8x1k	M8x1	4	11	6,5	10	18
VGL1079	404-006k	M10x1k	M8x1	4	14	6,5	10	18
VGL1002	406-004	M10x1k	M10x1	6	14	6,5	10	18
VGL1003	406-004k	M10x1k	M10x1	6	13	6,5	14	23
VGL1004	406-035k	M10x1k	M10x1	6	13	6,5	33	40

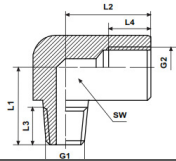

Código	Referencia	G1	G2	SW	L1	L2	L3	L4
Joelhos Macho Fêmea								
INT1042	955.502.040	M6x1k	M8x1	11	14,5	14,5	6,5	6,5
INT1043	955.502.042	M8x1k	M8x1	11	14,5	14,5	6,5	6,5
INT1044	955.502.044	M10x1k	M8x1	11	14,5	14,5	6,5	6,5

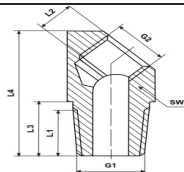

Código	Referencia	G1	G2	SW	L1	L2	L3	L4
Adaptadores a 45º Macho Fêmea								
VGL	406-145k	M8x1k	M10x1	12	6,5	5	10	23
VGL1155	406-045k	M10x1k	M10x1	13	4,5	6	7,5	21

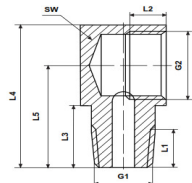

Código	Referencia	G1	G2	SW	L1	L2	L3	L4
Adaptadores a 90º Macho Fêmea								
VGL	406-089k	M8x1k	M10x1	12	6,5	4	10	23
VGL1154	406-090k	M10x1k	M10x1	12	6,5	4	10	23

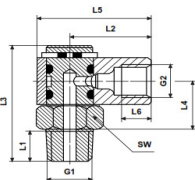

Código	Referencia	G1	G2	SW	L1	L2	L3	L4
Joelhos rotativos Macho Fêmea								
VGL1001	405-551-049	M10x1k	M8x1	7,5	8	12	32	12,5
VGL1152	405-549-049	M8x1k	M8x1	7,5	8	12	32	12,5

Tubagem e acessórios para sistemas de lubrificação

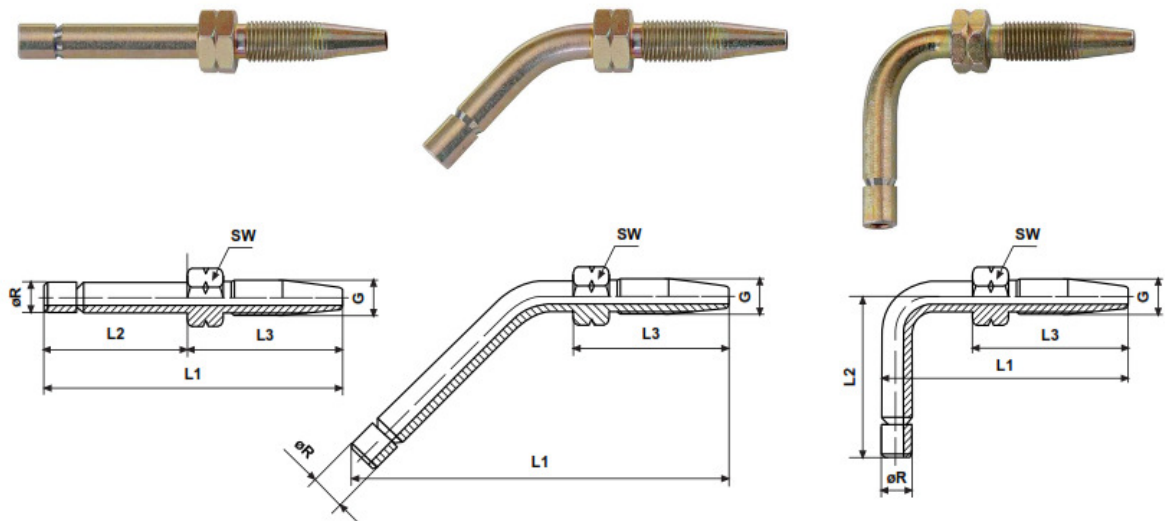

Código	Referencia	G	DN	R	SW	L1	L2	L3
Ponteiros reusáveis para tubo de borracha DN4								
VGL1013	853-380-002-VS	M7x0,75	4	6	10	61	30	31
VGL1014	853-380-003-VS	M7x0,75	4	6	10	47	36	31



Código	Referencia	G	DN	SW	L1	L2
Manguitos reusáveis para tubo de borracha DN4						
VGL1015	853-540-010	M7x0,75	4	12	28	19

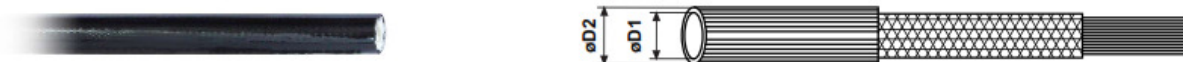

Código	Referencia	Rolo	DN	D1	D2	Raio
Tubo de lubrificação de alta pressão DN4 sem massa						
VGL1016	982-750-091	50 M	4	4	8,6	20 mm
Tubo de lubrificação de alta pressão DN4 com massa						
VGL1017	982-750-091+AF2	50 M	4	4	8,6	20 mm

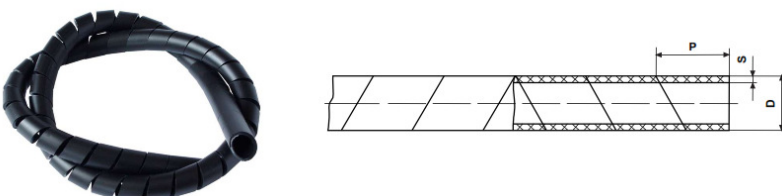

Código	Referencia	D	S	P	L
Proteção de enrolar					
VGL1018	982-760-121	12	1,5	10	50 M